

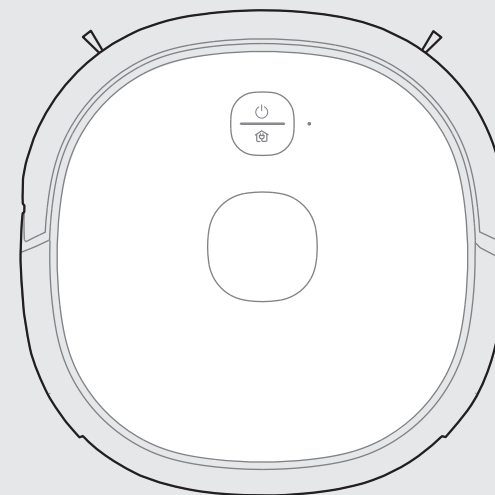

www.midea.com  
© Midea 2022 all rights reserved



Robot Vacuum Cleaner



SmartHome



Download the app  
& activate product

# USER MANUAL

M6

Warning notices: Before using this product, please read this manual carefully and keep it for future reference. The design and specifications are subject to change without prior notice for product improvement. Consult with your dealer or manufacturer for details. The diagram above is just for reference. Please take the appearance of the actual product as the standard.

## THANK YOU LETTER

Thank you for choosing Midea! Before using your new Midea product, please read this manual thoroughly to ensure that you know how to operate the features and functions that your new appliance offers in a safe way.

# CONTENTS

THANK YOU LETTER .....	01
SAFETY INSTRUCTIONS .....	02
SPECIFICATIONS .....	06
PRODUCT OVERVIEW .....	07
QUICK START GUIDE .....	09
PRODUCT INSTALLATION .....	13
OPERATION INSTRUCTIONS .....	14
APP SETUP AND OPERATION .....	18
CLEANING AND MAINTENANCE .....	20
TROUBLESHOOTING .....	24
TRADEMARKS, COPYRIGHTS AND LEGAL STATEMENT	27
DISPOSAL AND RECYCLING .....	27
DATA PROTECTION NOTICE .....	28
DOC AND CERIFICATIONS .....	29
DECLARATION OF CONFORMITY .....	29
CE .....	30

# SAFETY INSTRUCTIONS

## ⚠ Warning for the machine

1. This appliance can be used by children aged from 8 years and above and persons with reduced physical, sensory or mental capabilities or lack of experience and knowledge if they have been given supervision or instruction concerning use of the appliance in a safe way and understand the hazards involved.  
Children shall not play with the appliance.  
Cleaning and user maintenance shall not be made by children without supervision.
2. Plug must be removed from the socket-outlet before cleaning or maintaining the appliance. Switch off before cleaning or maintaining the appliance.
3. If the supply cord is damaged, it must be replaced by a special cord or assembly available from the manufacturer or its service agent.
4. **WARNING:** For the purposes of recharging the battery, only use the detachable docking station provided with this appliance.  
Use only with DC2106 docking station.
5. This appliance contains batteries that are only replaceable by skilled persons.
6. Do not bring the smart robot close to heat source, radiation or burning cigarette butts. It is strictly forbidden to vacuum the following objects:
  - 1) All liquids such as water and solvents;
  - 2) Lime, cement dust and other construction dust and garbage;
  - 3) Heat generating objects, such as unextinguished carbon butts, cigarette butts;
  - 4) Sharp fragments, such as glass, etc.;
  - 5) Flammable and explosive items, such as gasoline and alcohol products.
7. Before using, please remove all fragile items from the ground (such as glasses, lamps, etc.), and items that may be tangled with the side brush, Roller brush and drive wheels (such as wires, curtains and other easily-entangled materials).
8. Please pay attention to your hair and avoid entanglement on wheels or roller brushes when using, cleaning and maintaining the robot.
9. Do not use this product at an altitude of more than 2000m.
10. **Correct Disposal of this product.**  
This marking indicates that this product should not be disposed with other household wastes throughout the EU. To prevent possible harm to the environment or human health from uncontrolled waste disposal, recycle it responsibly to promote the sustainable reuse of material resources.  
To return your used device, please use the return and collection systems or contact the retailer where the product was purchased. They can take this product for environmental safe recycling.
11. **Warranty Information**  
The manufacturer provides warranty in accordance with the legislation of the customer's own country of residence, with a minimum of 1 year (Germany: 2 years), starting from the date on which the appliance is sold to the end user.  
The warranty only covers defects in material or workmanship.



The repairs under warranty may only be carried out by an authorized service centre. When making a claim under the warranty, the original bill of purchase (with purchase date) must be submitted.

The warranty will not apply in cases of:

- Normal wear and tear
- Incorrect use, e.g. overloading of the appliance, use of non-approved accessories
- Use of force, damage caused by external influences
- Damage caused by non-observance of the user manual, e.g. connection to an unsuitable mains supply or non-compliance with the installation instructions
- Partially or completely dismantled appliances

12. Wireless network: 2400-2483.5MHz, MAX POWER: 20dBm, BLUETOOTH MAX POWER: 10dBm

To satisfy RF exposure requirements, a separation distance of 20 cm or more should be maintained between the antenna of this device and persons during device operation. To ensure compliance, operations at closer than this distance is not recommended.

13. CLASS 1 LASER PRODUCT

INVISIBLE LASER RADIATION







(Note: Laser classified to Class 1 according to IEC 60825-1:2014)

### Warning for docking station

1. "IMPORTANT SAFETY INSTRUCTIONS - SAVE THESE INSTRUCTIONS" and "DANGER - TO REDUCE THE RISK OF FIRE OR ELECTRIC SHOCK, CAREFULLY FOLLOW THESE INSTRUCTIONS".
2. This appliance can be used by children aged from 8 years and above and persons with reduced physical, sensory or mental capabilities or lack of experience and knowledge if they have been given supervision or instruction concerning use of the appliance in a safe way and understand the hazards involved.  
Children shall not play with the appliance.  
Cleaning and user maintenance shall not be made by children without supervision.
3. Plug must be removed from the socket-outlet before cleaning or maintaining the appliance. Switch off before cleaning or maintaining the appliance.
4. If the supply cord is damaged, it must be replaced by a special cord or assembly available from the manufacturer or its service agent.
5. Docking base is only applicable to the product M6. (Battery pack type : Li-ion, DC 14.4 V, 3350 mAh)  
The Docking base will automatically start charging after Robot Vacuum Cleaner returned to the base.
6. Warning: The battery charger(Docking station) is not intended to charge non-rechargeable batteries.

### Warning for battery

1. The product must be powered off before removing the battery.
2. Please note that do not disassemble the battery by yourself.
3. If you need to replace it, please contact the after-sales service center.
4. Please dispose of used battery according to local laws and regulations
5. Do not dismantle, open or shred the battery.
6. Do not expose batteries to heat or fire. Avoid storage in direct sunlight.
7. Do not short-circuit a battery.
8. Do not store batteries haphazardly in a box or drawer where they may short-circuit each other or be short-circuited by other metal objects.
9. Do not subject batteries to mechanical shock.
10. In the event of a leaking, do not allow the liquid to come in contact with the skin or eyes. If contact has been made, wash the affected area with copious amounts of water and seek medical advice.
11. Do not use any charger other than that specifically provided for use with the equipment.
12. Do not use any battery which is not designed for use with the equipment.
13. Do not mix different manufacture, capacity, size or type within a device.
14. Keep batteries out of the reach of children.
15. Seek medical advice immediately if the battery has been swallowed.
16. Keep batteries clean and dry.
17. Do not leave a battery on prolonged charge when not in use.
18. After extended periods of storage, it may be necessary to charge and discharge the batteries several times to obtain maximum performance.
19. The batteries give their best performance when they are operated at normal room temperature (20 °C ± 5 °C).
20. Retain the original product literature for future reference.
21. The battery may be irreversibly damaged if the battery is in low power for a long time. It is recommended that the battery retain sufficient power before storage.

	[symbol IEC 60417-5957 ( 2004-12 )]	for indoor use only
	[symbol ISO 7000-0790 ( 2004-01 )]	read operator's manual
	[symbol IEC 60417-5031 ( 2002-10 )]	direct current
	time-lag miniature fuse-link where X is the symbol for the time/current characteristic as given in IEC 60127	
	[symbol IEC 60417-5032 ( 2002-10 )]	alternating current
	[symbol IEC 60417-5172 ( 2003-02 )]	class II equipment

## Intended Use

The following safety guidelines are intended to prevent unforeseen risks or damage from unsafe or incorrect operation of the appliance. Please check the packaging and appliance on arrival to make sure everything is intact to ensure safe operation. If you find any damage, please contact the retailer or dealer. Please note modifications or alterations to the appliance are not allowed for your safety concern. Unintended use may cause hazards and loss of warranty claims.

## Explanation of Symbols



### Danger

This symbol indicates that there are dangers to the life and health of persons due to extremely flammable gas.



### Warning of electrical voltage

This symbol indicates that there is a danger to life and health of persons due to voltage.



### Warning

The signal word indicates a hazard with a medium level of risk which, if not avoided, may result in death or serious injury.



### Caution

The signal word indicates a hazard with a low degree of risk which, if not avoided, may result in minor or moderate injury.



### Attention

The signal word indicates important information (e.g. damage to property), but not danger.



### Observe instructions

This symbol indicates that a service technician should only operate and maintain this appliance in accordance with the operating instructions.

Read these operating instructions carefully and attentively before using/commissioning the unit and keep them in the immediate vicinity of the installation site or unit for later use!

# SPECIFICATIONS

Product Model	M6
Host Charging Voltage	16.7V
Host Rated Voltage	14.4V
Host Rated Power	40W
Docking Station Model	DC2106
Docking Station Input	100-240V~, 50-60Hz, 24W
Docking Station Output	16.7V  , 1A
Battery Model	BP14433A
Battery Rated Voltage	14.4V
Battery Capacity	3350mAh 48.24Wh
Charging Limit Voltage	16.8V

Midea Robozone Technology Co.,Ltd.

Add.: No.39 Caohu Avenue, Xiangcheng Economic Development Zone, Suzhou, Jiangsu, China

Company: KD EUROPE

Add.: Stara Debszczyszna 4, 16-424, Filipow, Poland

Mail: Kdeurope.office@gmail.com

# PRODUCT OVERVIEW

## Product

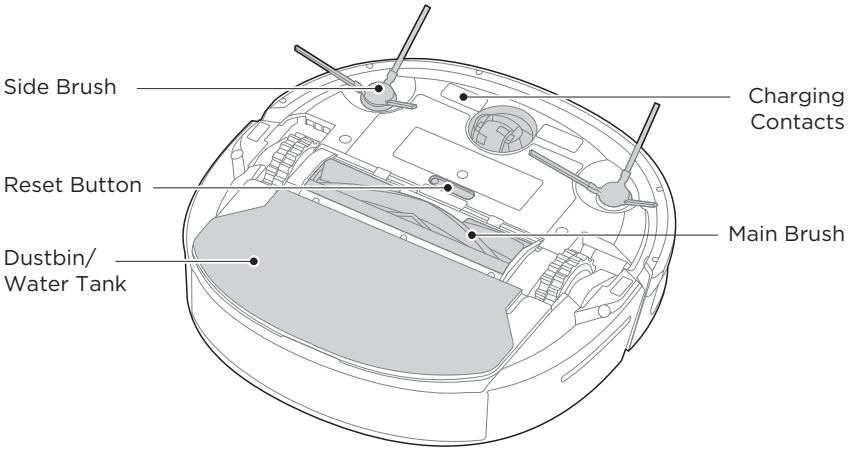
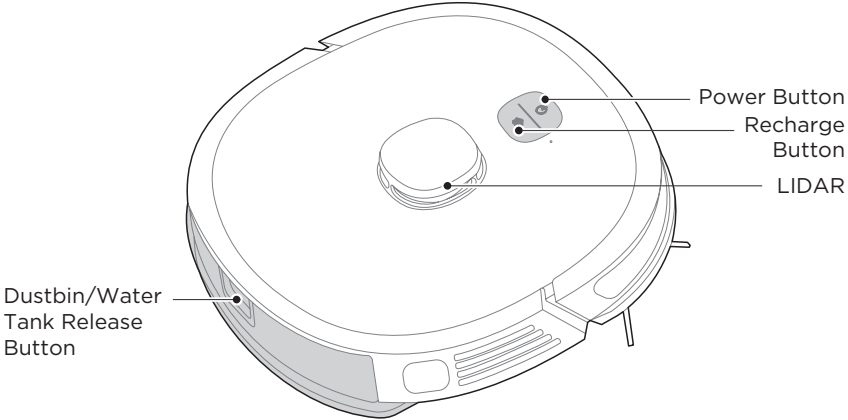

## Accessories

Charging Base x1

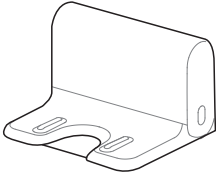

Power Cable x1



Filter x1

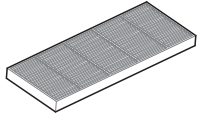

Mop Cloth Holder x1



Mop Cloth x1

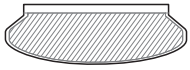

Side Brush x2

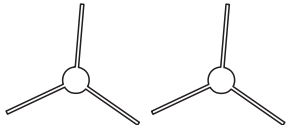

Cleaning Brush x1



Manual x1



# QUICK START GUIDE

## First Use

Step 1  
Remove the protection bar.

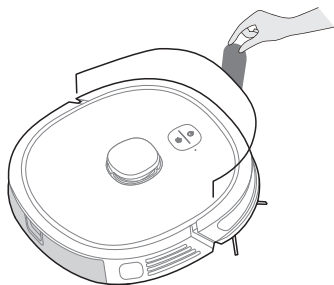

Step 2  
Place the charging base on a level surface that is free of obstacles.

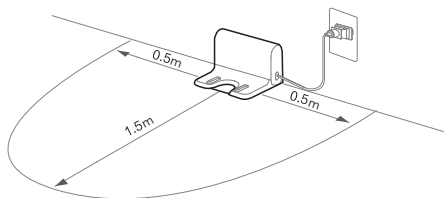

Step 3  
Install side brushes to their color-matching posts.

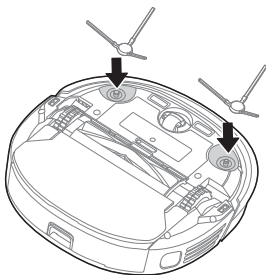

Step 4  
Before first use, we recommend you charge the robot for at least 6 hours. Press and hold to turn on robot for App connection.

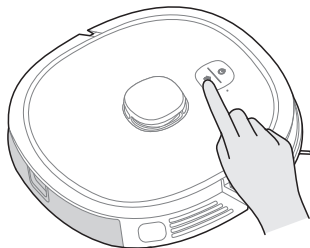

Step 5  
Short press or use App to start cleaning.

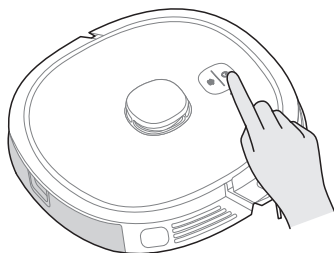

Step 6  
Recharging for next cleaning.

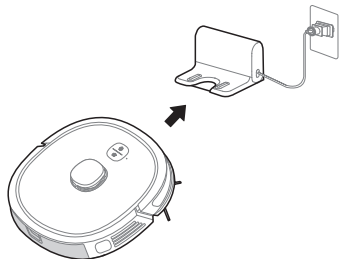

## Water Tank Use Guide

Step 1  
Remove the dustbin from the robot.

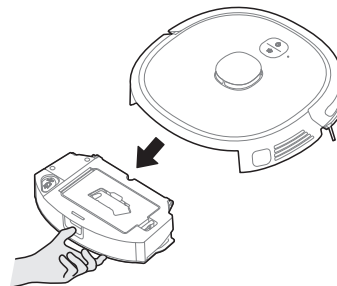

Step 2  
Open the rubber tank lid and fill the tank with cold water. (Electric parts inside. Please do not immerse the tank into water.)

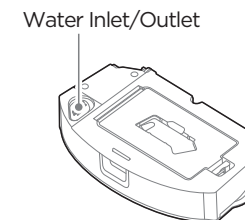

Step 3  
Attach the mop cloth as shown to start mopping.

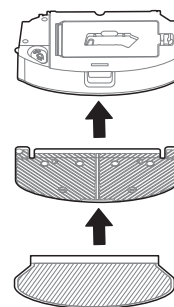

Step 4  
Wipe the electrical control interface with a dry, soft cloth to ensure it is clean and dry.

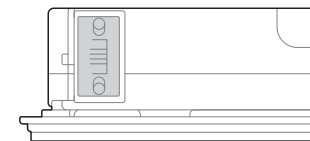

Step 5  
Assemble the prepared water tank into the robot.

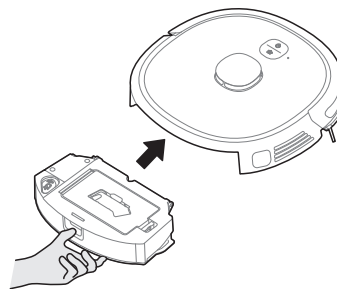

Step 6  
Start the robot (please do not use mopping function on carpet).

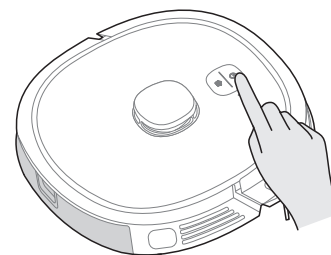

## APP & Voice Control



2.4GHz  
Wireless  
network



iOS 13.0 or later  Android 8.0 or later



Applicable to Google Assistant & Amazon Alexa:

Skill Name for Google Assistant  
"SmartHome"

Skill Name for Amazon Alexa  
"SmartHome"

### NOTE

For using Google Assistant and Amazon Alexa, please make sure SmartHome APP has been downloaded and matched with your robot successfully.

Step1. Download SmartHome APP and link your robot successfully.

Step2. Get your Amazon Alexa or Google Assistant device ready.

Step3. By searching skill name above to link voice device and your robot.

(SmartHome account need to be registered in the process)

Step4. Voice-control your robot by using voice commands in the description.

	start	stop	charge
Google	start <robot name> turn on <robot name> switch on <robot name>	stop <robot name> turn off <robot name> switch off <robot name>	dock <robot name> <robot name> go home <robot name> go charge
Alexa	turn on <robot name>	turn off <robot name>	set charge mode on

# PRODUCT INSTALLATION

## Installation of Charging Base

1. Make sure the power cable is connected into the charging base.
2. Place the charging base flat against a wall and make sure there leaves enough space to the base, as shown in the figure below.
3. Ensure the charging base is connected to a power supply.

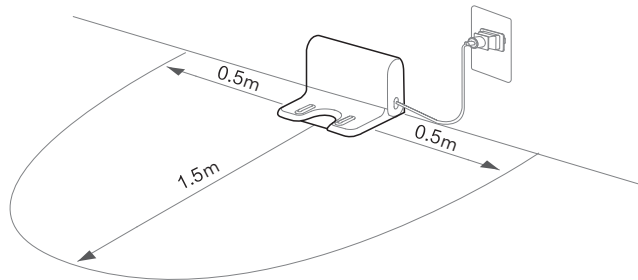

## Installing the Side Brushes

1. Turn the unit over.
2. Attach the correct color side brush to the matching post and press down until they fit into place.
3. Ensure side brushes can rotate freely.

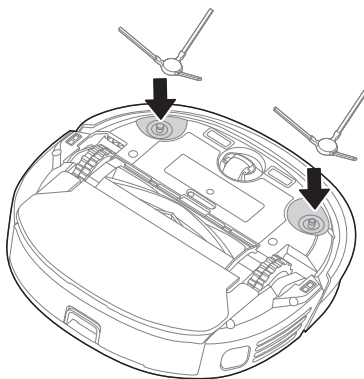

# OPERATION INSTRUCTIONS

## Function of Buttons

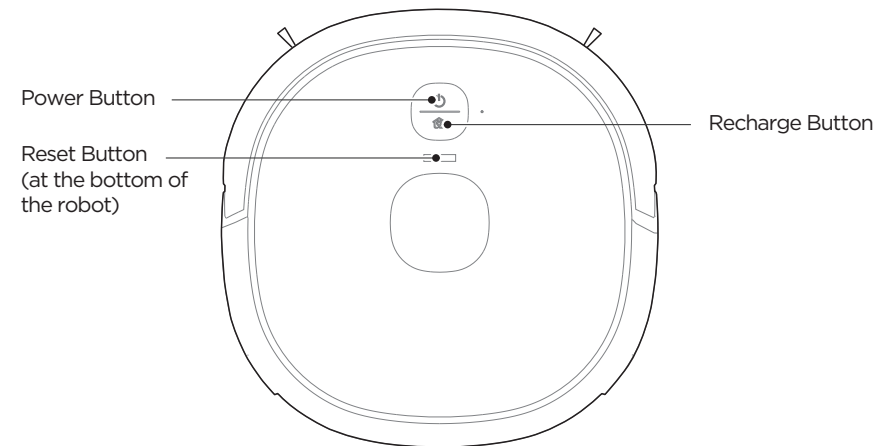

### Start / Pause / Shut Down

Press and hold to turn on the robot.

**Start:** Short press  button or use App to start cleaning.

**Pause:** Short press to pause the cleaning. To resume cleaning, briefly press again.

**Shut Down:** Press and hold the power button to turn off the robot. A shut down sound will be heard. Note that robot will not be turned off if it is on the charging base.

### Networking

Press and hold the network pairing button for network configuration. Robot is in pairing status if the light is flashing.

### Recharge

Short press  button to recharge.

### Reset

Press "Reset" button to reset the robot if it is not responding or does not function properly.

## Charging Robot Vacuum

1. Press and hold the power button to turn on the robot.

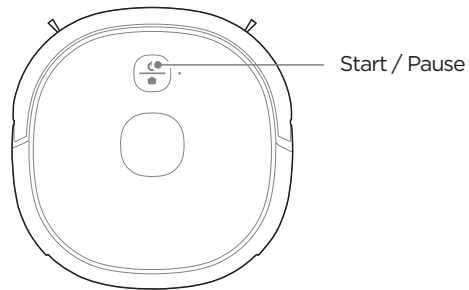

2. Place the robot on the charging base to start charging. We recommend that you charge the robot for at least 6 hours before using it for the first time.

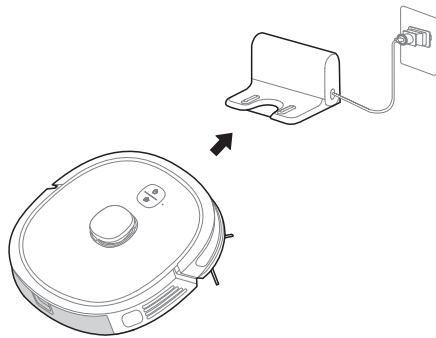

### NOTE

1. Please do not place the charging base on carpets or soft floors and keep the area dry.
2. Remove the mopping cloth holder when the robot is under the charging state.
3. To make sure the robot is always ready for use, we suggest that you keep the robot charged on the charging base. For long-term storage, remove the robot from the base and store it in a cool & dry place.
4. If the robot is not used for more than 3 months, allow it to get charged for at least 12 hours before using.
5. To preserve the battery lifespan, we suggest you fully charge the battery at least once every six months.
6. The robot will not start to clean if the battery level is too low, please charge it before starting to clean.
7. During the cleaning, the machine will automatically return to recharge when the battery energy is running low; after it is fully charged, it will go back to where it left off and resume cleaning.
8. The robot will enter sleep mode when it is in standby mode for more than 10 minutes. In sleep mode, press any key to wake up the robot vacuum.
9. Under special circumstances (such as power depletion, robot vacuum jamming, etc.), the robot vacuum may not be able to recharge automatically. Please manually place the robot vacuum back to the charging base.
10. Do not immerse the robot in water. Doing so may damage the equipment, causing short-circuit or current leakage.

## Cleaning

Please clean up the wires and sundries scattered on the ground and remove precious, fragile and dangerous items that are easy to fall before cleaning.

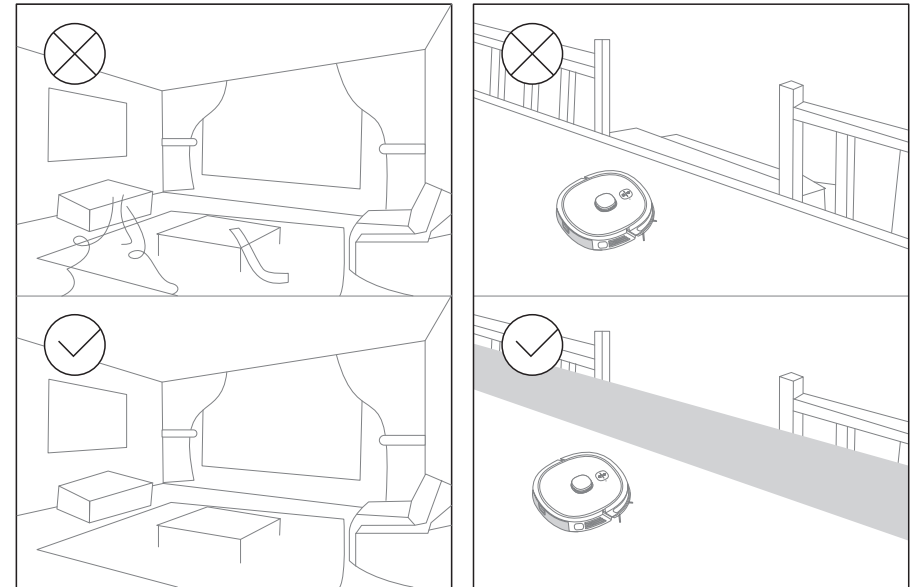

During its first cleaning job, it is recommended to follow the robot to find some possible problems. The robot can clean much more smoothly after that. If certain area do not need to be cleaned, you can add No-Go Zones or Virtual Walls on the map via the app to prevent the robot from entering the specified area.

### NOTE

Do not use your robot on wet surfaces or surfaces with standing water. Before using the product on a rug with tasseled edges, please fold the rug edges under.

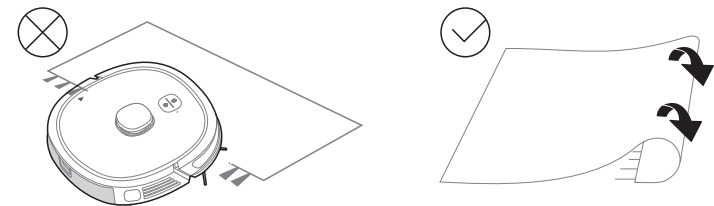

## Mopping

1. Check and ensure the mop cloth is attached to the mop cloth holder.

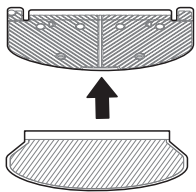

2. Press the release button on the water tank and pull to remove.

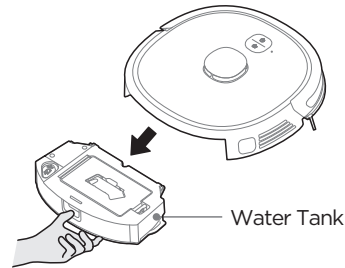

3. Fill the water tank. Open the lid, fill the tank with water, and securely close the lid.

Water Inlet/Outlet

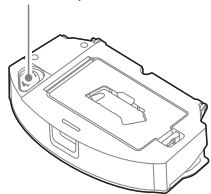

4. Attach the mopping cloth holder to the water tank.

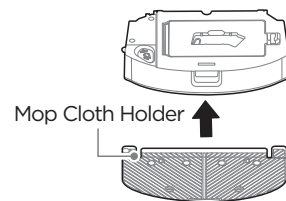

5. Re-insert the water tank assembly into the robot. You hear a click sound when the water tank is installed properly.

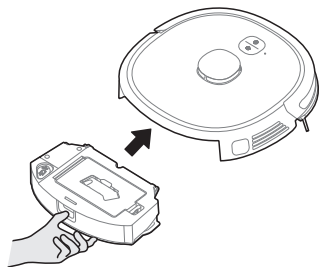

6. Press “⏻” to start mopping. If you don't want the robot to go on your carpet when mopping, set a No-go zone/virtual wall via App or roll up the carpet.

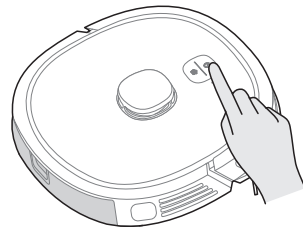

### NOTE

- a) Please do not exceed the “Max” water level.
- b) It is recommended to use clean water in the water tank. Do not add any detergent in the water to prevent clogs. Do not use hot water.
- c) Please clean the mopping cloth after cleaning.
- d) Remove the mopping cloth holder when the robot is under the charging state.
- e) You can adjust water flow via APP according to your requirement.

## APP SETUP AND OPERATION

### NOTE

If your home wireless network name or password is changed, you will need to re-established connection with your robot vacuum.

1. App supports iOS 13.0 and above, Android 8.0 and above phone system versions, but Pad device is not accepted; generally the phone system version may be checked by clicking “Setting- About Mobile Phone”.
2. This model does not support WEP encrypted router.
3. The network accessing configuration of the cleaner requires wireless network of 2.4GHz frequency range, 5GHz frequency range is currently incompatible.
4. Wireless network is mandatory for network accessing configuration of the cleaner; once the network accessing is configured successfully, App may be operated in wireless network/2G/3G/4G/5G network environment and the cleaner may be controlled remotely.
5. If your home wireless network password is changed, the cleaner will be displayed as off-line on App; Without any changes of App account number, one just needs to configure network accessing for the cleaner once again.
6. If others want to use App to operate same cleaner, they need to be invited on App by the device owner by sharing the device to the new user's account (on the condition that the invitee has downloaded App and has registered an account).
7. The device will be removed from the former device owner's device list if a new account owner connect the device successfully.
8. Once the cleaner is configured successfully network accessing, the following operations will result in clearance of wireless network settings and secondary network accessing configuration is required; Long press the network accessing configuration key on the device for over 3 seconds, and after a tick sound is heard, all wireless network information will be cleared.

1. Ensure the mobile phone is connected to your home wireless network. Also please turn on the Bluetooth on your phone. If not, go to Settings and turn it on.

2. Download the SmartHome app and register your robot:
  - a. Scan the QR code or search for the SmartHome app in the Apple or Google Play Store. Download the app.
  - b. Open the app and create your personal account. Follow instructions on the screen.



3. Add your robot vacuum to your app. Press the “+” button on the main screen of the app and select M6 from the available list of products.

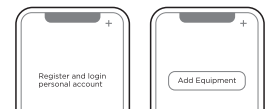

4. Connect your robot to your wireless network. After assembling and powering on the robot, press and hold the “🏠” button until a beep sound is heard. The network indicator light should start flashing. Follow instructions on app for next steps.

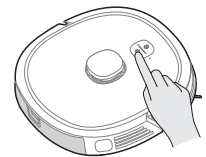

## SmartHome App Quick Guide

### NOTE

If the wireless network in your home is unstable, it may cause a certain delay in the related operations of the App. (The content of the SmartHome App is subject to change with the product technology update. Please refer to the SmartHome interface for details).

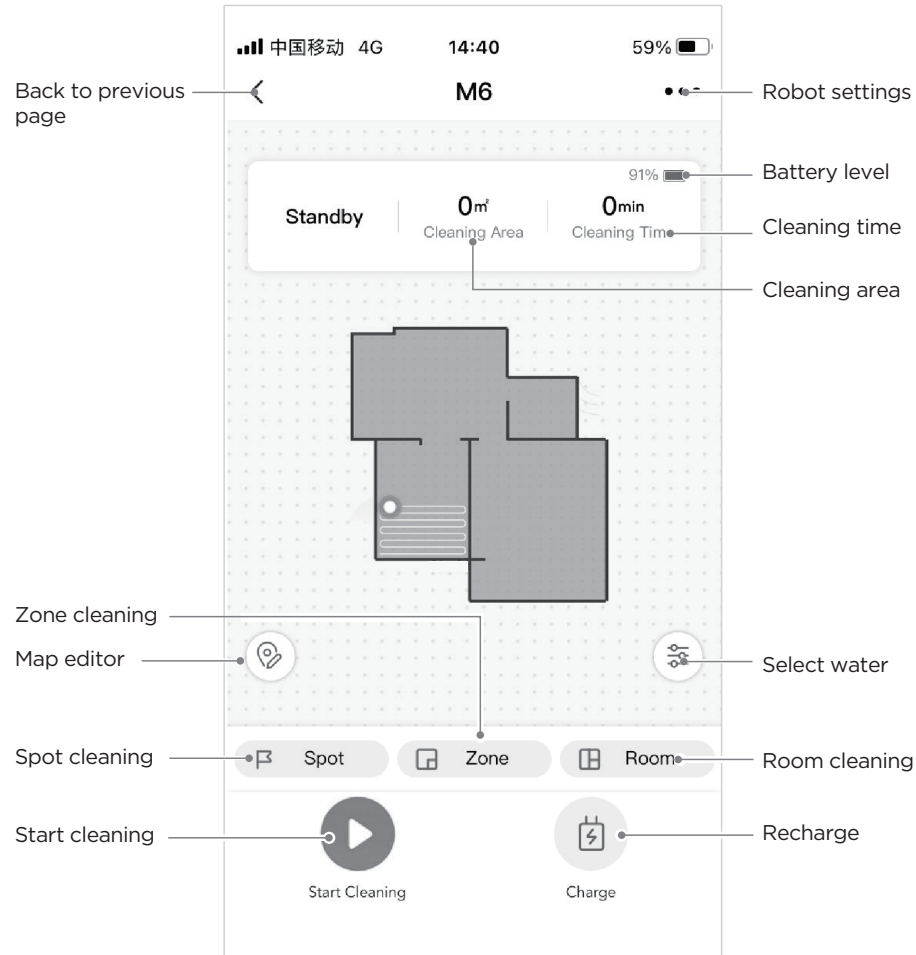

## CLEANING AND MAINTENANCE

### Cleaning the Main Brush

1. Turn over the main unit. Remove the cover and take out the main brush. Use the cleaning brush or scissors to clean the tangled hair or debris.

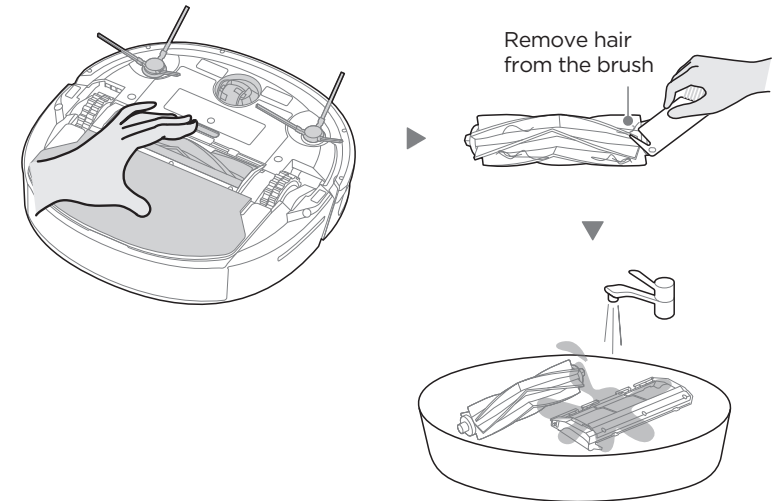

2. Dry the main brush and cover thoroughly, and then reinsert them back in the robot. It is recommended to clean the main brush every week and replace it every 6-12 months.

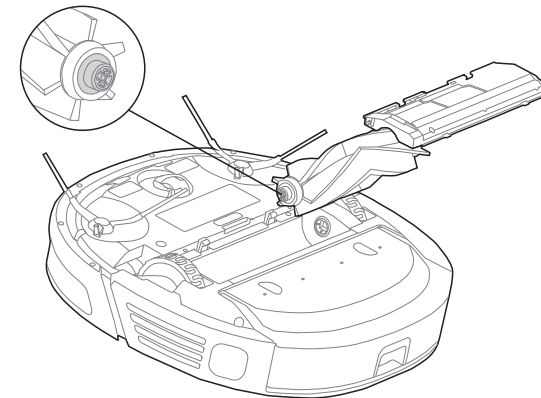

## Cleaning the Side Brush

1. Pull to remove the side brushes. Remove any tangled hair, debris, and then reinstall them.
2. It is recommended to clean the side brushes every week and replace them every 6-12 months.

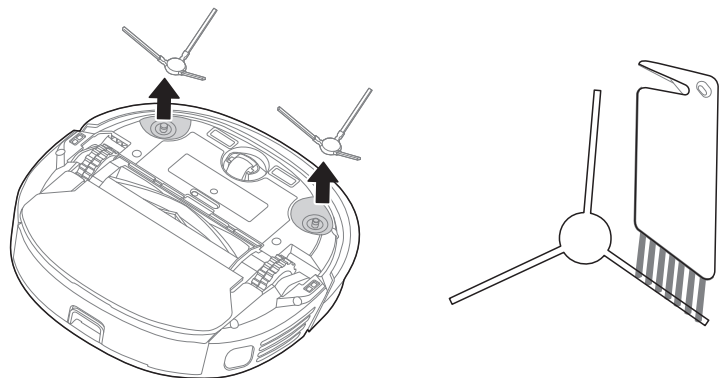

### NOTE

If side brushes are curled, you can remove them and place in warm water (Suggested 30 - 50°C) for 30 seconds and then let it thoroughly dry.

## Cleaning the Dustbin and Filter Element

### NOTE

Empty the dustbin after each use.

1. Press dustbin release button to remove dustbin from robot.

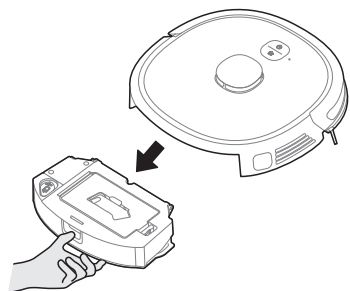

2. Open the top cover of the dustbin to pour out the dust.

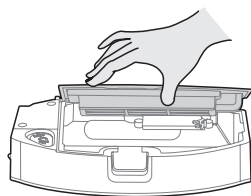

3. Take the filter out from the dustbin. Remove debris by tapping the filter against your garbage bin. You can clean the filter with water, but remember to dry it **THOROUGHLY** before reinserting it back into the dustbin.

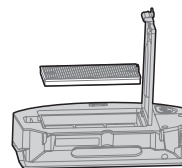

4. Reinsert the dustbin back in the robot. It is recommended to clean the filter element every week and replace it every 1-3 months.

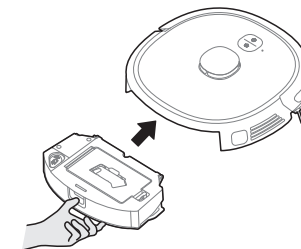

## Cleaning the Water Tank

1. Once finished mopping, press the water tank release button and pull to remove the water tank. Detach the mop cloth holder by pulling them apart.

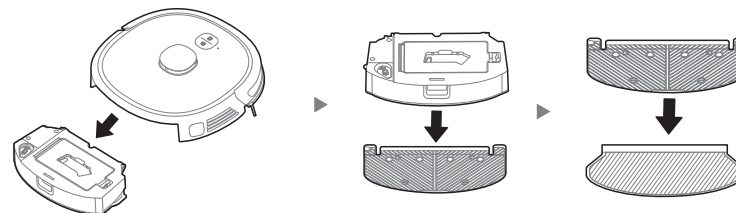

2. Wash the mopping cloth and dry **THOROUGHLY**.

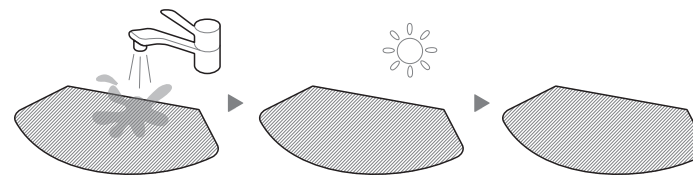

3. Open the cover and pour out the remaining water in the water tank.

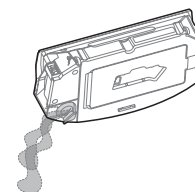

4. Wipe dry the water tank. Exposure to sunlight is not recommended.

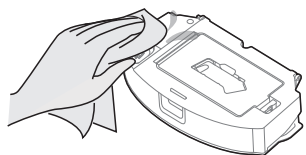

### Cleaning the Sensor and Wheel

Wipe the sensors and wheels gently with a dry, soft cloth, as shown in the figure.

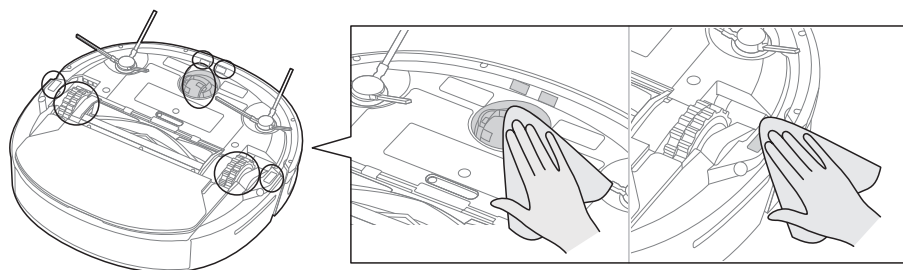

### Cleaning the Charging Contacts

Wipe the charging contacts on both the robot and the charging base with a dry, soft cloth, as shown in the figure.

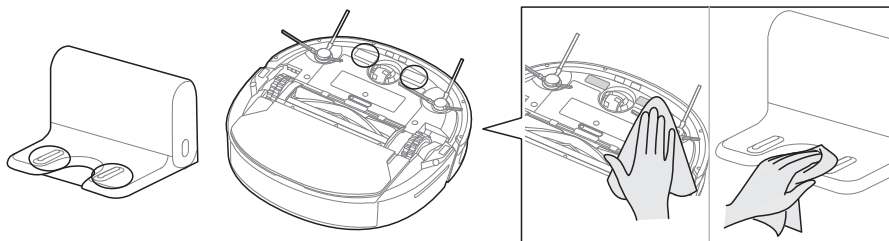

## TROUBLESHOOTING

Operation of your appliance can lead to errors and malfunctions. The following tables contain possible causes and notes for resolving an error message or malfunction. It is recommended to read the tables carefully below in order to save your time and money that may cost for calling to the service center.

If you have after-sales problems, it is recommended to go to SmartHome-Help-Contact us/Feedback for help.

Problem	Possible reason	Solution
The appliance will not be charged.	• The power switch is not turned on while charging.	Power on the appliance.
	• The appliance and charging terminals are not in full contact.	Make sure the appliance is fully in contact with the charging terminal.
The appliance gets stuck.	• The appliance is covered by wires on the ground, dropping curtain fabric or blankets are twined.	The appliance will automatically start the escape mode. If it is not out of trouble, it needs manual help.
	• Side brush and main brush, etc. get stuck, and the appliance cannot run normally.	Clean the windings on the side brush and restart it. If not, contact the post-sales department.
Not cleaned completely, and recharge it.	• The appliance does not have enough battery power.	Charge the appliance.
No cleaning according to the present time.	• The power switch is not on.	Turn on the power switch of appliance.
	• Scheduled appointment is cancelled.	Reset and make appointment.
After the mop holder is installed, the appliance is impermeable.	• The mop holder magnet falls off.	Contact the aftersales service center.
	• There's no water in water tank.	Add water.
	• The appliance base outlet hole is blocked.	Clear water outlet and tank filter.

Problem	Possible reason	Solution
The appliance has missed sweeps, there is no plan for cleaning, and the map in the app shows irregularly.	<ul style="list-style-type: none"> <li>The ground is slippery.</li> </ul>	If the floor is waxed, dry it before use.
	<ul style="list-style-type: none"> <li>Wires, shoes and other objects placed on the ground, affecting the normal operation of the appliance.</li> </ul>	Minimize ground items as much as possible.
	<ul style="list-style-type: none"> <li>Cleaning is interrupted halfway.</li> </ul>	Do not move or block the appliance during work.
Appliance does not work.	<ul style="list-style-type: none"> <li>The power switch is not turned on.</li> </ul>	Turn on the power switch.
	<ul style="list-style-type: none"> <li>Low battery.</li> </ul>	Charge the appliance.
	<ul style="list-style-type: none"> <li>Wheels are dropped and the three groups of drop sensors are in a falling state.</li> </ul>	Place the appliance close to the ground. If necessary, contact post-sales service center.
Appliance retreats.	<ul style="list-style-type: none"> <li>There is an obstacle ahead.</li> </ul>	Clear the front obstacles.
	<ul style="list-style-type: none"> <li>Bumper rail is clamped.</li> </ul>	Tap the bumper rail to check for if there is foreign matter stuck.

Problem/Cause	Troubleshooting	Solution
<b>Problem:</b> App displays disconnection.  <b>Cause:</b> Disconnection between the mobile phone and the appliance.	<ul style="list-style-type: none"> <li>Check if the mobile phone is accessed to network.</li> </ul>	The mobile phone shall be accessed to network once again.
	<ul style="list-style-type: none"> <li>Check if the router works normally.</li> </ul>	Re-start the router.
	<ul style="list-style-type: none"> <li>The cleaner is required to be powered.</li> </ul>	Power on the cleaner once again.
	<ul style="list-style-type: none"> <li>The wireless network configurations of the equipment are cleared.</li> </ul>	Add new appliances into App.
	<ul style="list-style-type: none"> <li>The wireless network password or network is changed.</li> </ul>	After system start-up, long press network pairing button and release it after a tick sound is heard; clear all wireless network configurations of the cleaner and add household electrical appliances once again for operation.
<b>Problem:</b> Slow App operation.  <b>Cause:</b> Network connection is not so smooth.	<ul style="list-style-type: none"> <li>Network busy.</li> </ul>	Re-start the router and reduce the number of access users.
	<ul style="list-style-type: none"> <li>Poor wireless network signal reception of the mobile phone.</li> </ul>	Check the settings of the mobile phone itself.
	<ul style="list-style-type: none"> <li>The network bandwidth is not so adequate.</li> </ul>	Broaden network bandwidth.
Unable to scan the QR code	<ul style="list-style-type: none"> <li>Try another mobile phone for confirmation.</li> </ul>	Try another mobile phone to scan; Add appliance by product category.

# TRADEMARKS, COPYRIGHTS AND LEGAL STATEMENT

Midea logo, word marks, trade name, trade dress and all versions thereof are valuable assets of Midea Group and/or its affiliates (“Midea”), to which Midea owns trademarks, copyrights and other intellectual property rights, and all goodwill derived from using any part of an Midea trademark. Use of Midea trademark for commercial purposes without the prior written consent of Midea may constitute trademark infringement or unfair competition in violation of relevant laws.

This manual is created by Midea and Midea reserves all copyrights thereof. No entity or individual may use, duplicate, modify, distribute in whole or in part this manual, or bundle or sell with other products without the prior written consent of Midea.

All the described functions and instructions were up to date at the time of printing this manual. However, the actual product may vary due to improved functions and designs.

## DISPOSAL AND RECYCLING

### Important instructions for environment

Compliance with the WEEE Directive and Disposing of the Waster Product:  
This product complies with EU WEEE Directive (2012/19/EU). This product bears a classification symbol for waster electrical and electronic equipment (WEEE).

This symbol indicates that this product shall not be disposed with other household wastes at the end of its service life. Used device must be returned to official collection point for recycling of electrical electronic devices. To find these collection systems please contact to your local authorities or retailer where the product was purchased. Each household performs important role in recovering and recycling of old appliance. Appropriate disposal of used appliance helps prevent potential negative consequences for the environment and human health.



### Compliance with RoHS Directive

The product you have purchased complies with EU RoHS Directive (2011/65/EU). It does not contain harmful and prohibited materials specified in the Directive.

### Package information

Packaging materials of the product are manufactured from recyclable materials in accordance with our National Environment Regulations. Do not dispose of the packaging materials together with the domestic or other wastes. Take them to the packaging material collection points designated by the local authorities.



## DATA PROTECTION NOTICE

For the provision of the services agreed with the customer, we agree to comply without restriction with all stipulations of applicable data protection law, in line with agreed countries within which services to the customer will be delivered, as well as, where applicable, the EU General Data Protection Regulation (GDPR).

Generally, our data processing is to fulfil our obligation under contract with you and for product safety reasons, to safeguard your rights in connection with warranty and product registration questions. In some cases, but only if appropriate data protection is ensured, personal data might be transferred to recipients located outside of the European Economic Area.

Further information are provided on request. You can contact our Data Protection Officer via [MideaDPO@midea.com](mailto:MideaDPO@midea.com). To exercise your rights such as right to object your personal data being processed for direct marketing purposes, please contact us via [MideaDPO@midea.com](mailto:MideaDPO@midea.com). To find further information, please follow the QR Code.

# DOC AND CERTIFICATIONS

## Declaration of Conformity

Unique identification of this DoC: M3LDS-001

We Midea Robozone Technology Co.,Ltd.

No.39 Caohu Avenue, Xiangcheng Economic Development Zone, Suzhou, Jiangsu,

China

### responsibility that the product:

product name: Robot Vacuum Cleaner

trade name: Midea/eureka/Comfee

type or model: M3LDS, VCR21, Tornado, CFR08, M6, NER600

to which this declaration relates is in conformity with the essential requirements and other relevant requirements of the Directive:

2014/53/EU 2011/65/EU (EC)No 1907/2006

The product is in conformity with the following standards and/or other normative documents:

2014/53/EU : EN 60335-2-2:2010 +A11:2012 + A1:2013

EN 60335-1:2012+A11:2014+AC:2014+A13:2017+A1:2019+A14:2019+A2:2019

EN 62311: 2008 EN 62233: 2008

EN 301 489 -1 V2.2.3 EN 301 489 -17 V3.2.4 EN 55014 -1:2017+A11:2020 EN 55014-2:

2015

EN IEC 61000-3-2: 2019 EN 61000-3-3:2013+A1: 2019 EN 300 328 V2.2.2

2011/65/EU : EN 62321-1:2013 EN 62321-2:2014 EN 62321-3-1:2014

EN 62321-4:2014 EN 62321-5:2014 EN 62321-6:2015 EN 62321-7-1:2015

EN 62321-7-2:2017 EN 62321-8:2017

Supplementary information:

Technical file held by: Midea Robozone Technology Co.,Ltd.

Place and date of issue (of this DoC): CHINA 2021 -7-30

Signed by or for the manufacturer

(Signature of authopised person)

Name (in print):

Title: Quality Manager

Shawn

## CE

Midea hereby declares that the appliance with MSmartHome functionality meets the essential requirements and other relevant provisions of the Directive 2014/53/EU. A detailed RED Declaration of Conformity can be found online at [www.midea.com](http://www.midea.com) among the additional documents on the product page for your appliance.



2.4 GHz band:100mW max.